

The logo for ARIDA X-RAY SCAN SYSTEMS is displayed in white against a dark grey background. It features a stylized icon on the left, resembling an eye or a camera lens, composed of two curved shapes. To the right of the icon, the word "ARIDA" is written in a large, bold, sans-serif font. Below "ARIDA", the words "X-RAY SCAN SYSTEMS" are written in a smaller, all-caps, sans-serif font.

ARIDA
X-RAY SCAN SYSTEMS





Zeszuta Sp. z o.o.

ul. Garbarska 79, 26-600 Radom

tel: 048 360 87 75

fax: 048 360 87 47

zeszuta@zeszuta.pl

www.arida.pl

STATIONARY SCANNERS	2-15
BASIC SCANNER	16
MOBILE SCANNERS	17-21
CITAN MOBILE SCANNER	22-24
GATE SCANNER	25-26

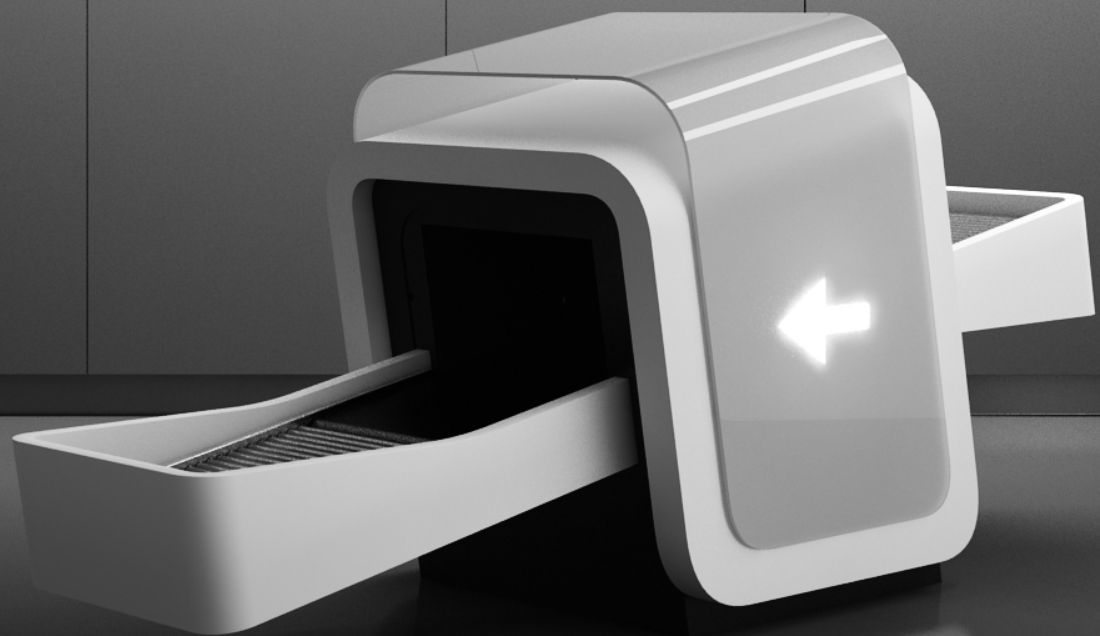

 ARIDA STATIONARY SCANNERS

ARIDA FLEXI

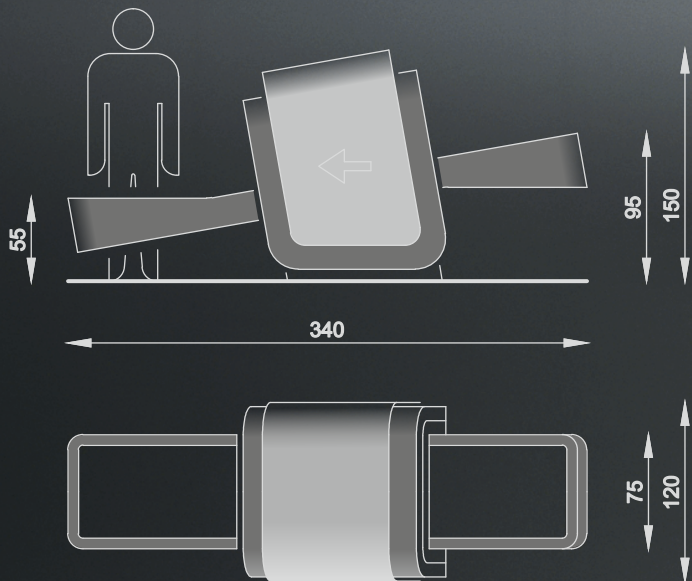
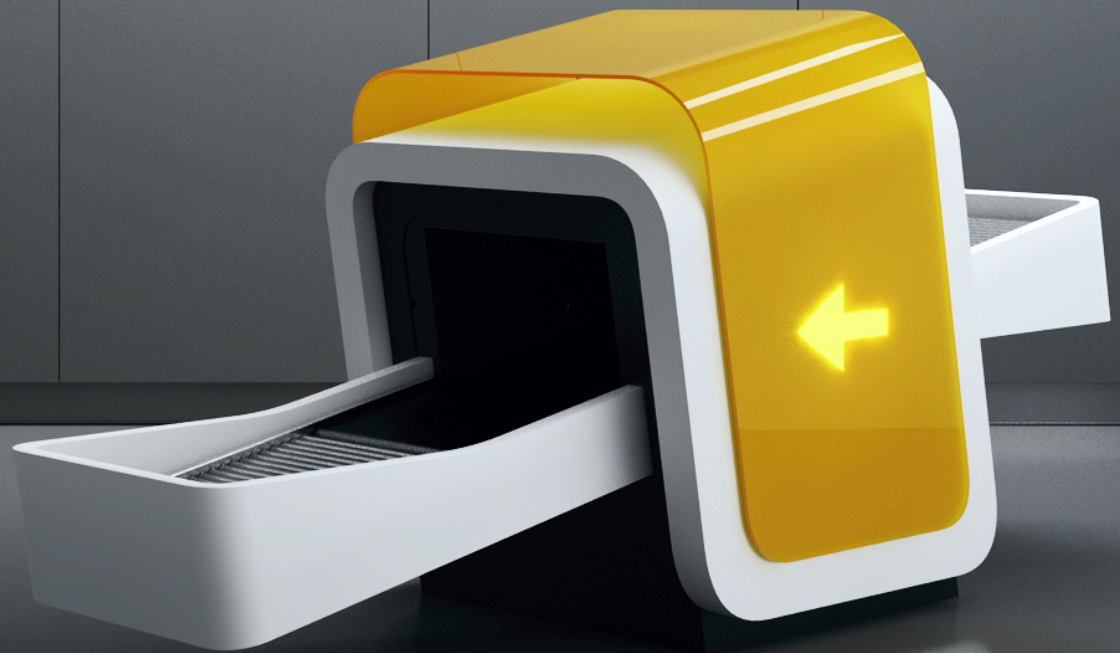

Scanning device sometimes shouldn't scare object visitors. It can have a friendly look and very well blend in with the character of the interior. Arida FLEXI is a modern, lightweight, ergonomic and extremely easy-to-use model. A fully functional system supports the machine operator in the diagnosis of all the threats. The user can choose the color of the housing exactly according to the tastes.

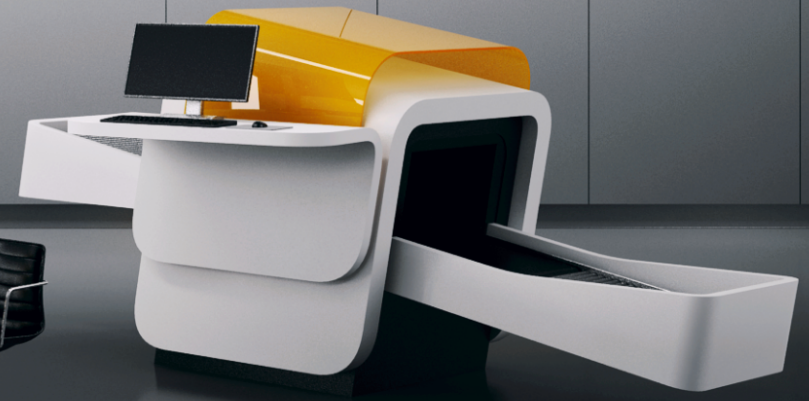
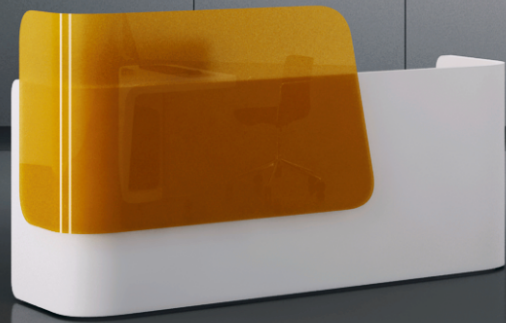

COMPONENTS OF THE SYSTEM

- the maximum of ergonomics

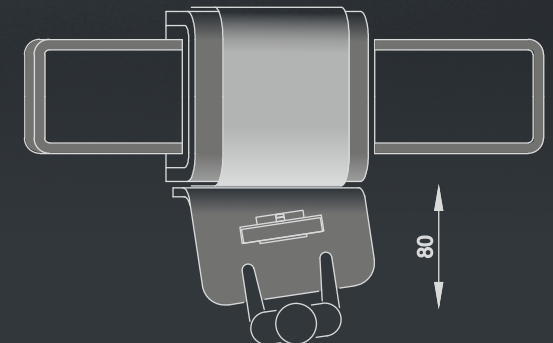
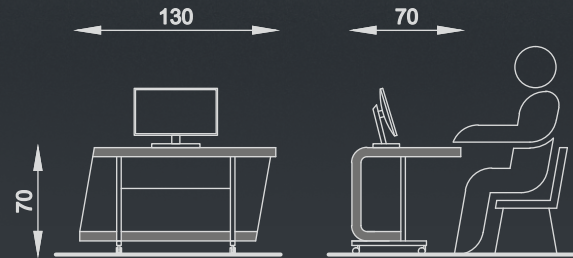
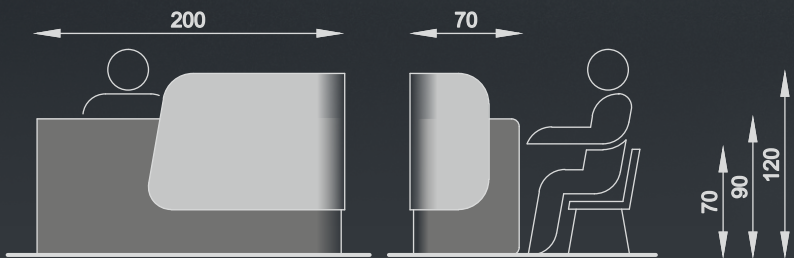

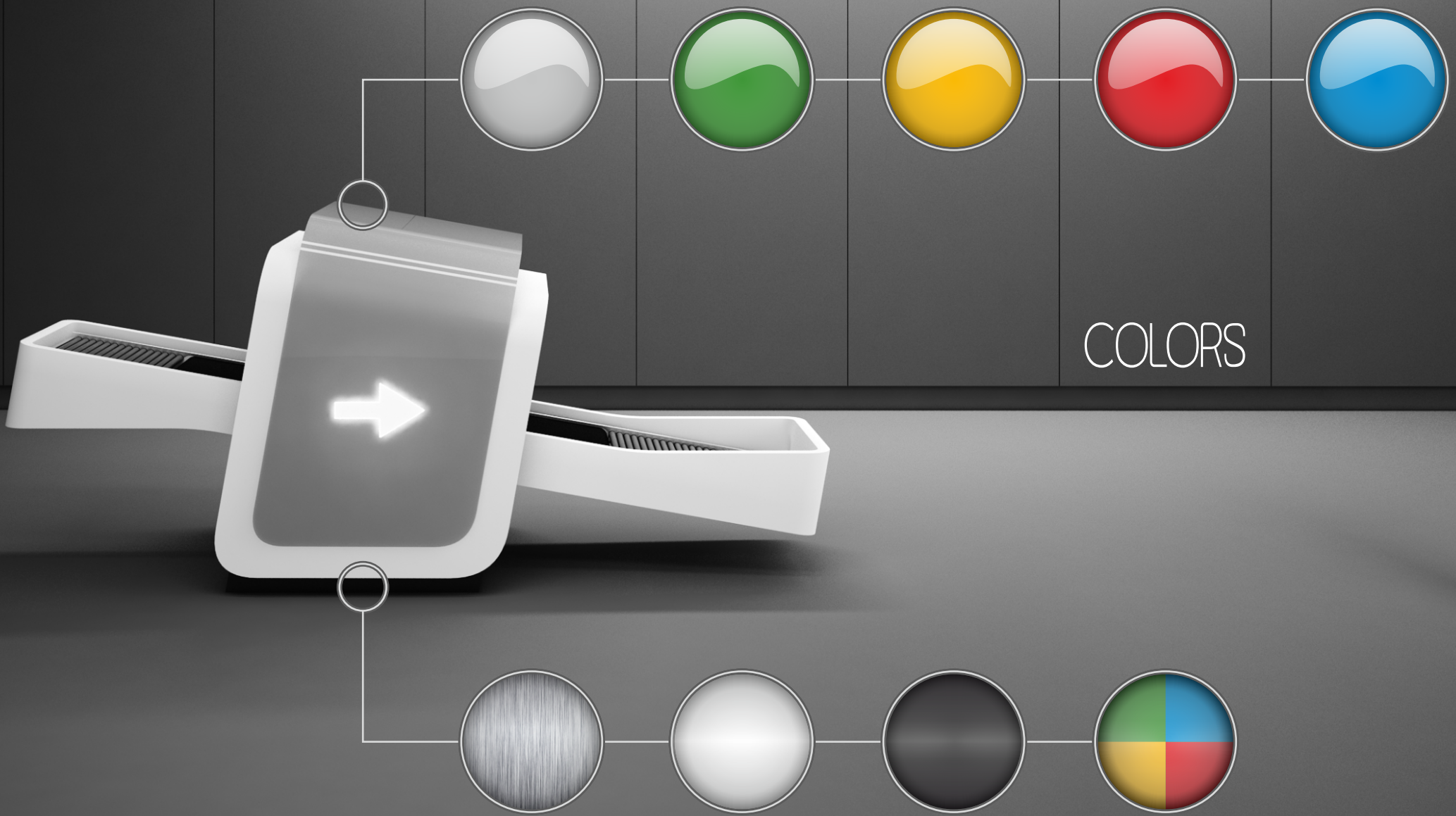

COLORS

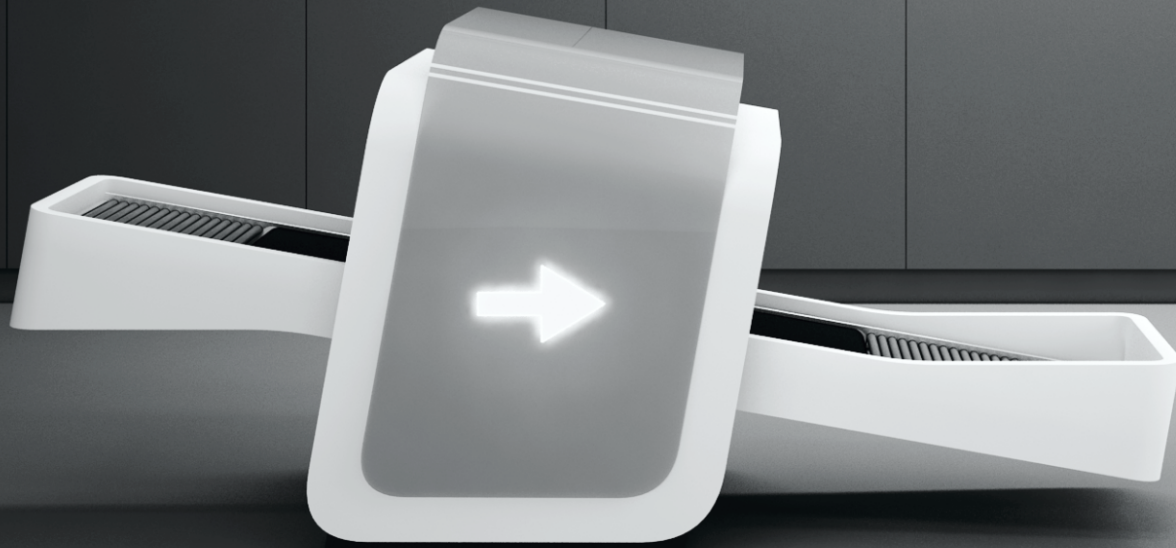

The examples of colors mix

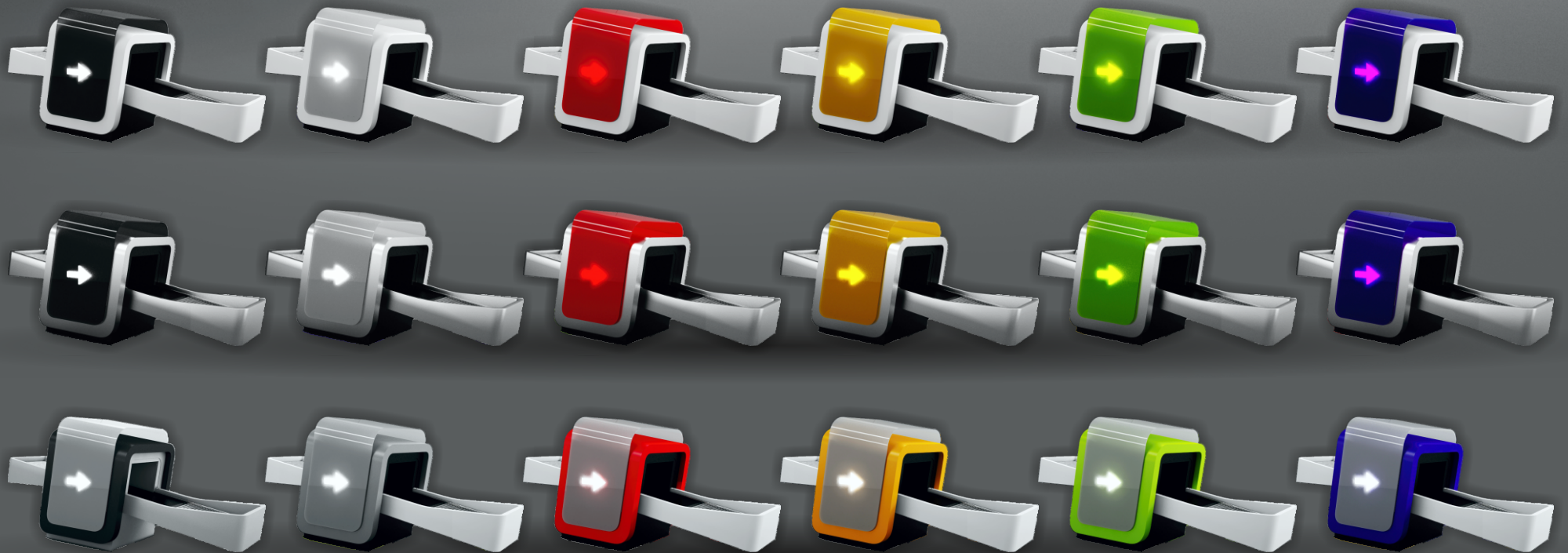

Modern, stylistically refined interiors require that all components correspond with the overall design. The scanning device is usually one of the first objects of which meets the visitor's eyes. Elegance combined with full functionality are the features of the ARIDA MODERN. Versions are available in colors specially prepared to a specific customer order.



 ARIDA MODERN





ELEMENTS

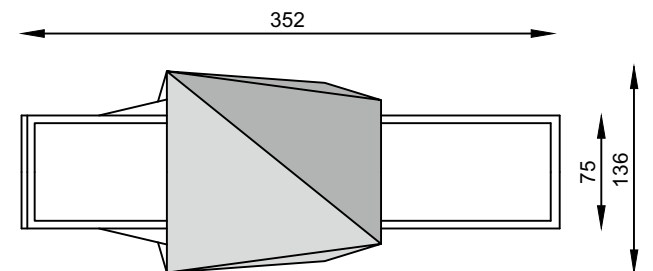
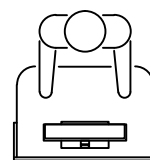
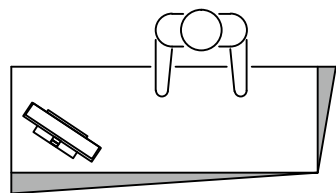
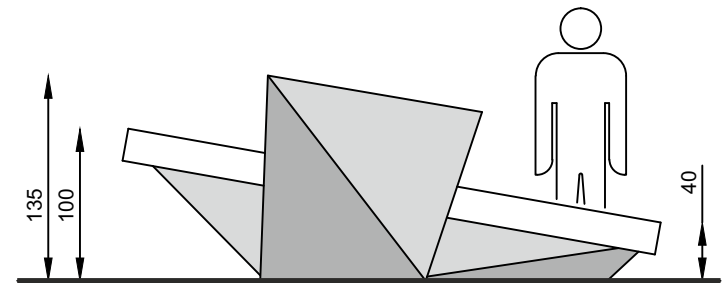
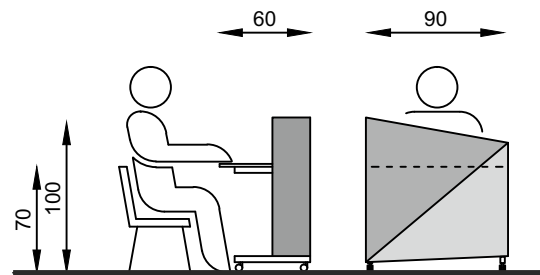
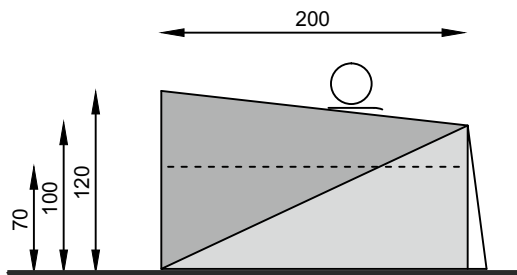

Contemporary stylistically refined interiors require that all components correspond with the overall design. The scanning device is usually one of the first objects of which meets the visitor's eyes. Modernity, elegance, simplicity combined with full functionality are the features of the model TECHNO. It fits perfectly into technic interiors. Versions are available in colors specially prepared a specific customer order.



 ARIDA TECHNO



ELEMENTS

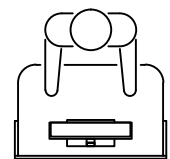
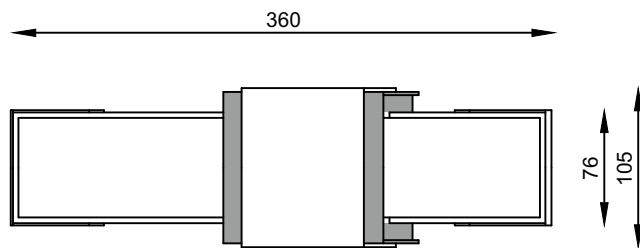
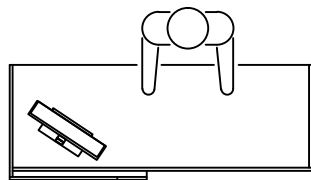
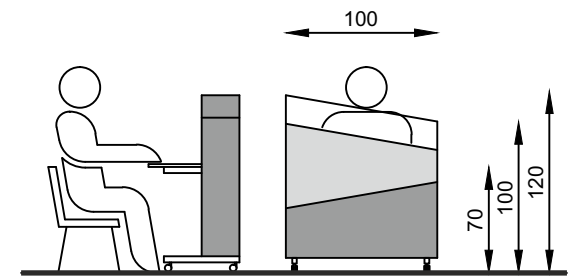
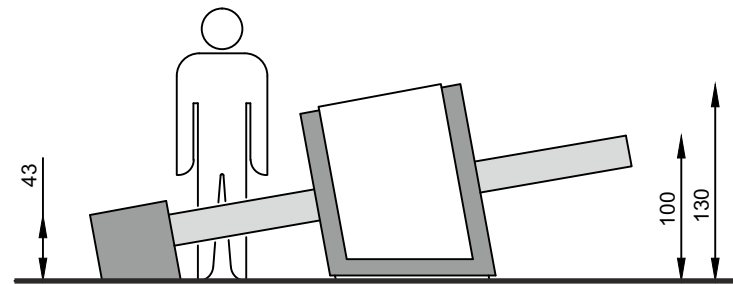
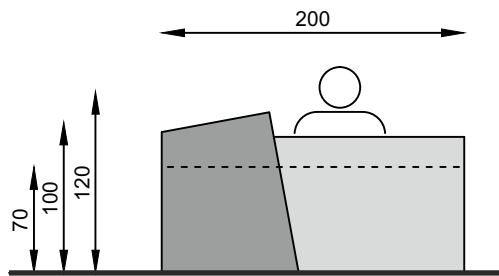

ARIDA ETNO



Contemporary interior is characterized by different design. Sometimes the ETNO scanner, as the best solution would be perfectly integrated into the nature of the inside decoration.

The lightness and simplicity combined with full functionality are the features of the model ETNO. Ideally suited to museums. Versions are available in colors specially prepared a specific customer order.

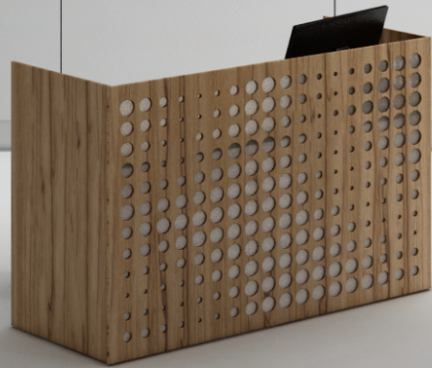

ELEMENTS

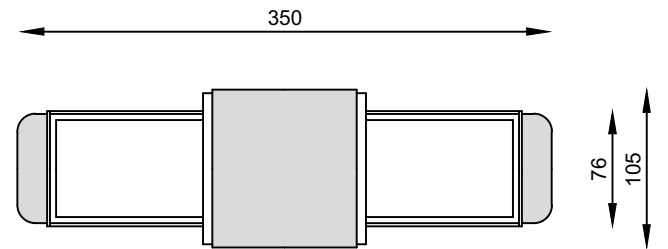
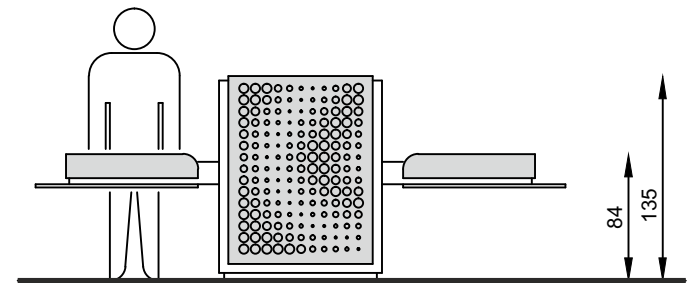
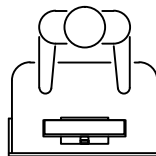
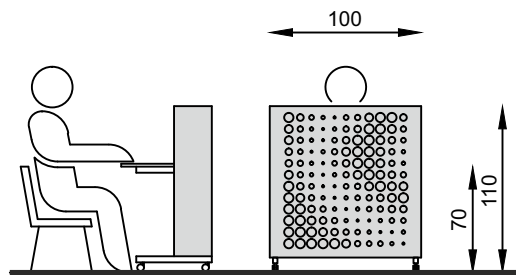
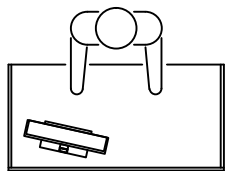
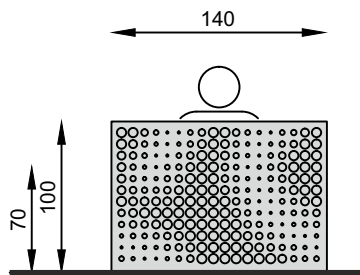

ARIDA ORIENT

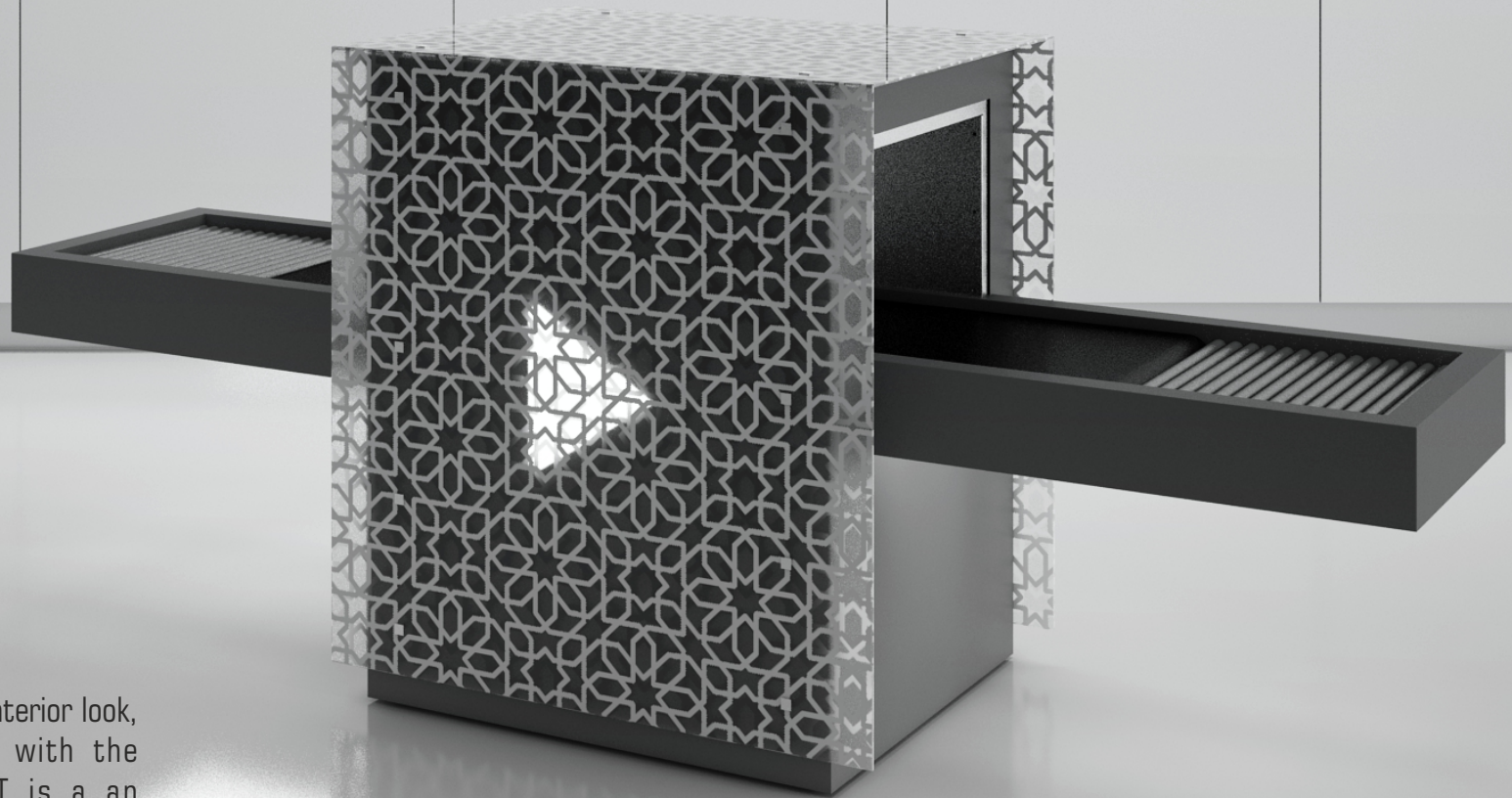

An oriental design, sophisticated interior look, requires a device that fit in with the surroundings. Model ORIENT is a an embodiment of special requirements. Maximum simplicity and full functionality. A simple block body and lightness look. It fits perfectly into the interior decorated in oriental style. On request it is possible to prepare special color versions.

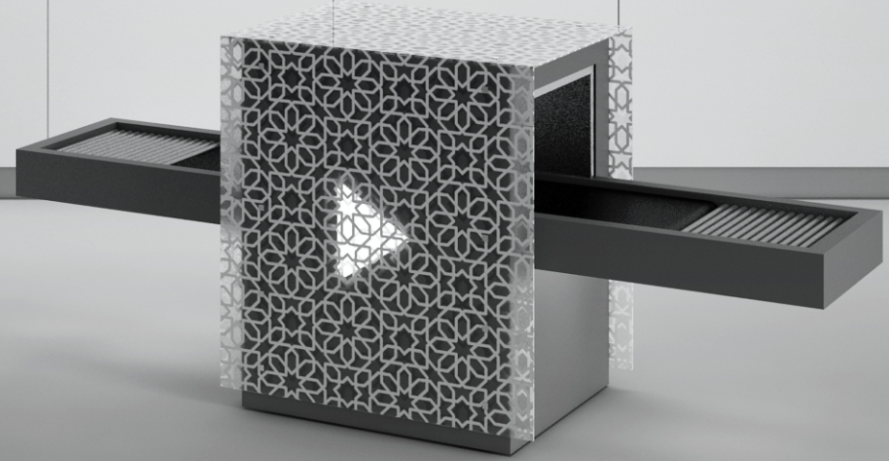
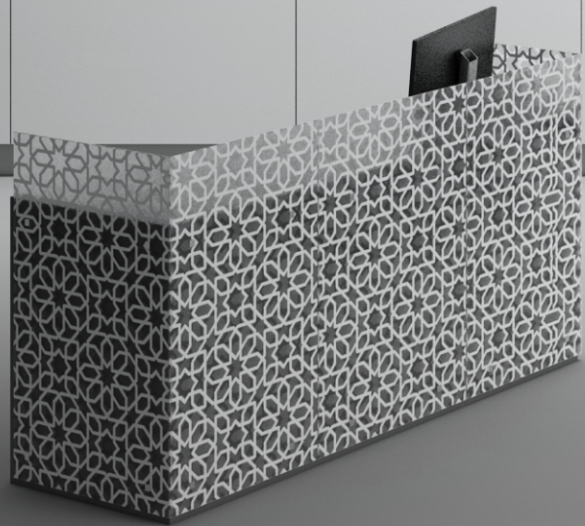

ELEMENTS

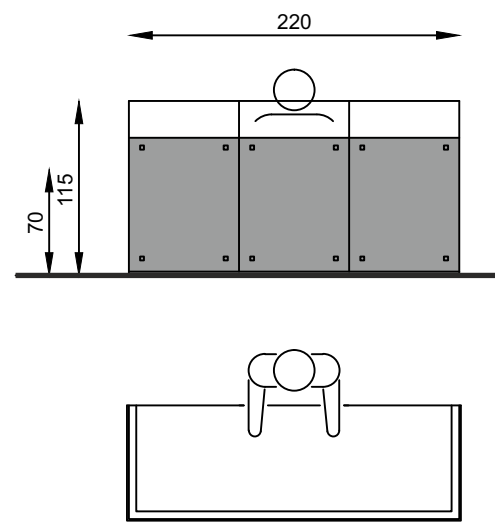
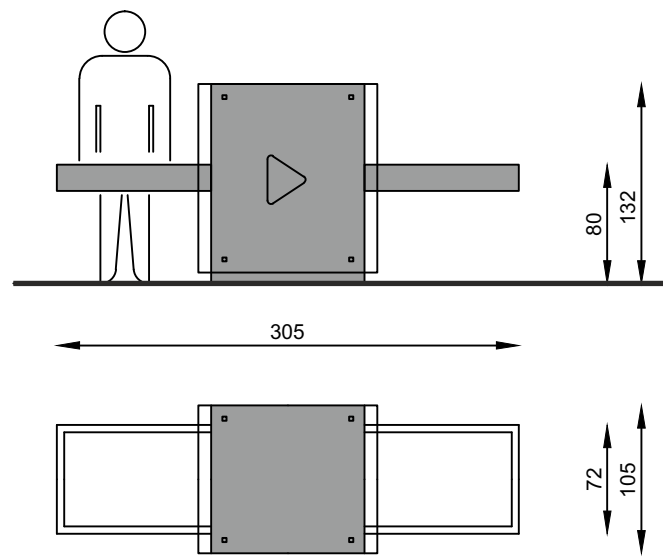

Model BASIC is a budget solution. It offered the cheapest model with numerous possibilities of expansion. Ideal for buildings and wherever low cost solution is the most important feature. A fully functional system provides all the possibilities of detection. This solution is ideal for integration with other systems. Special housing - available on request.

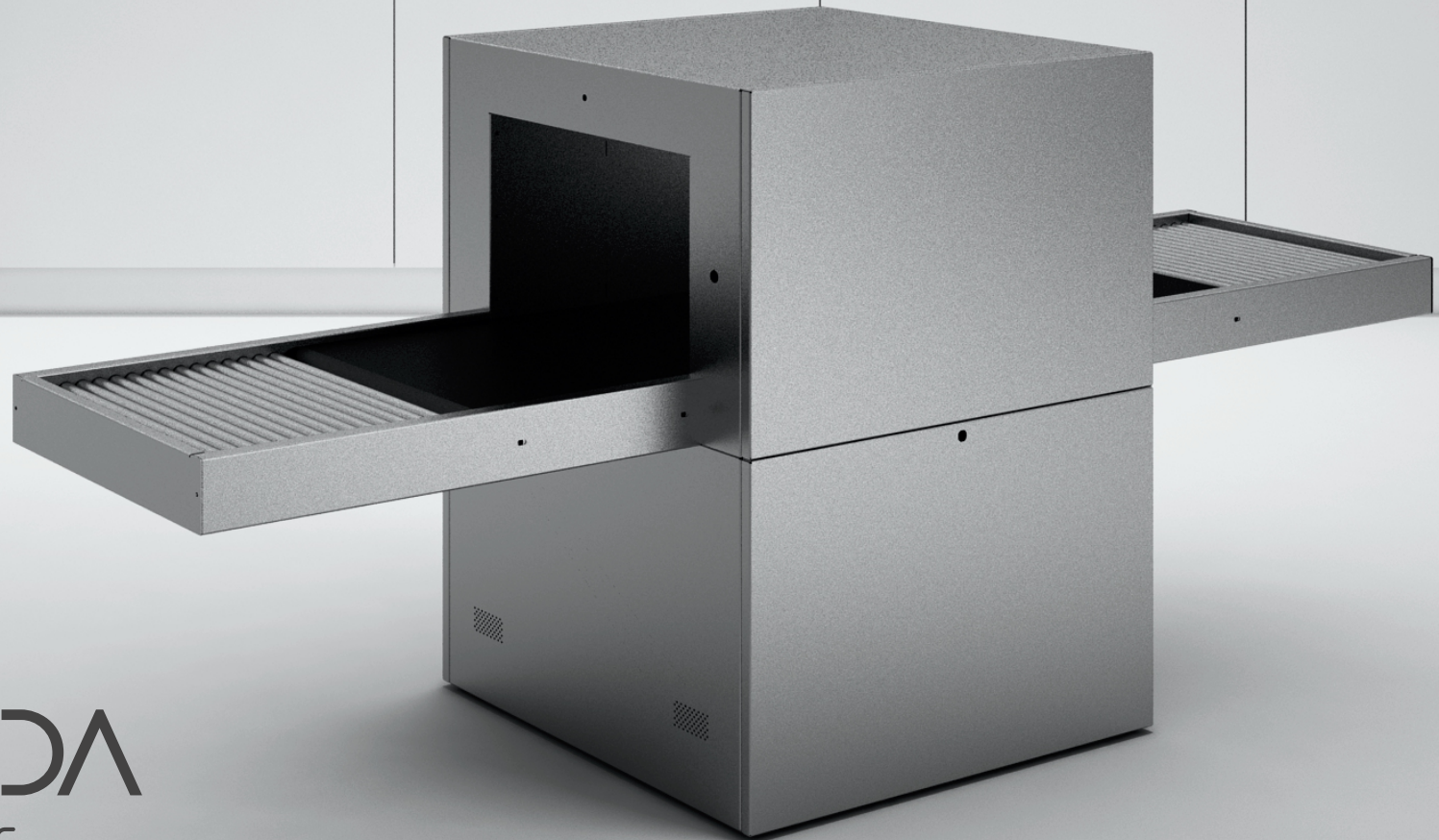

 **ARIDA**
BASIC



ARIDA MOBILE SCANNERS

Mobile scanner gate is an absolute novelty. It allows you to scan large objects anywhere. Light based on the construction of the aluminum arm is convenient to use and provides full mobility. Invaluable in detecting explosives and contraband. Ask the dealer for details.

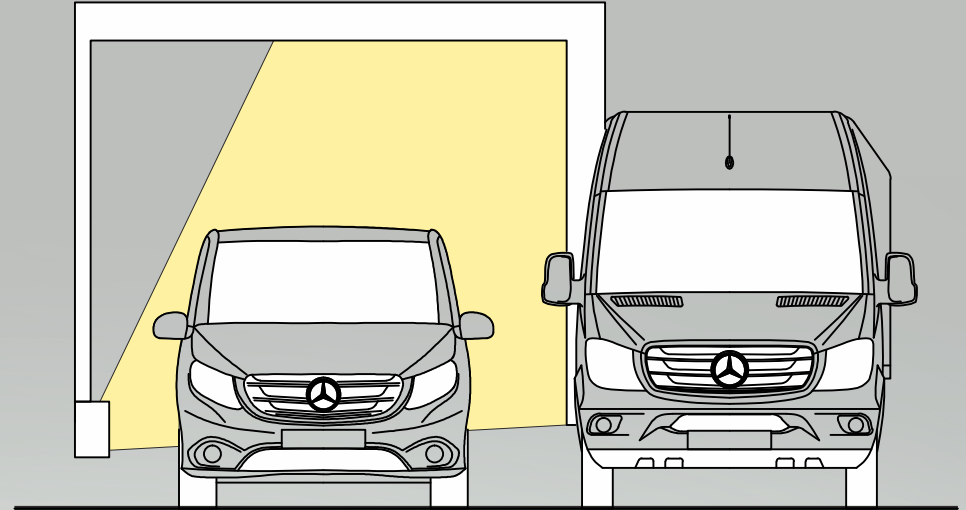

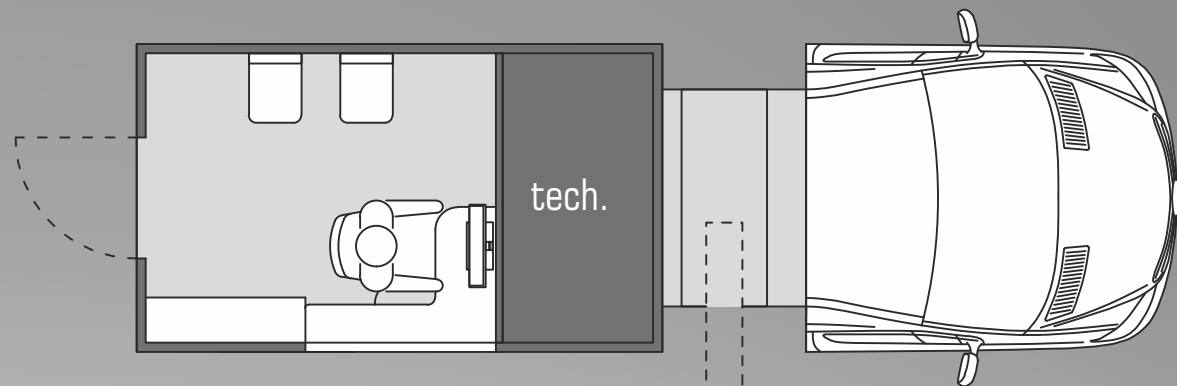

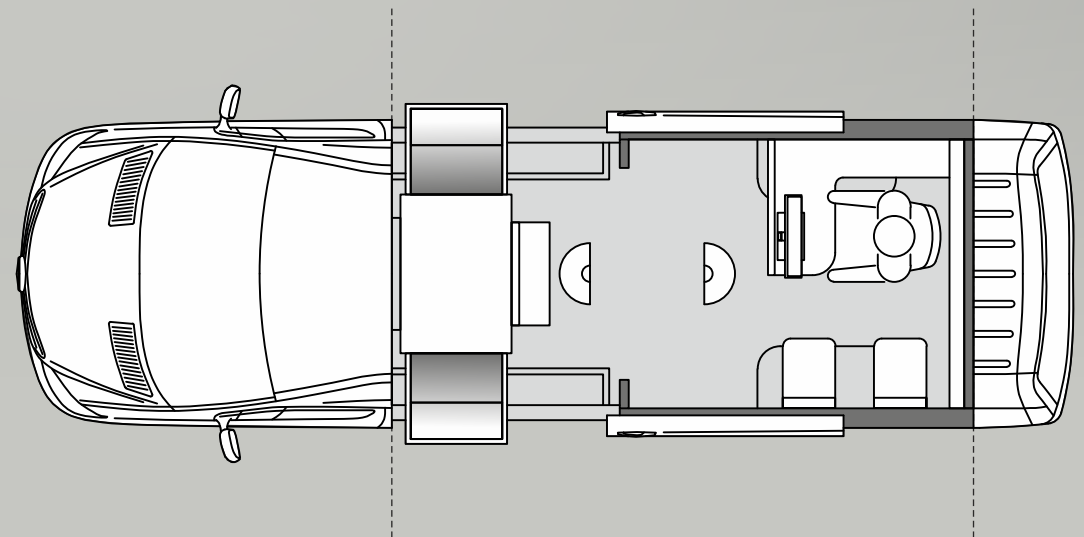
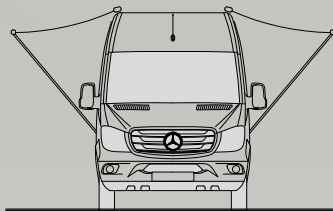
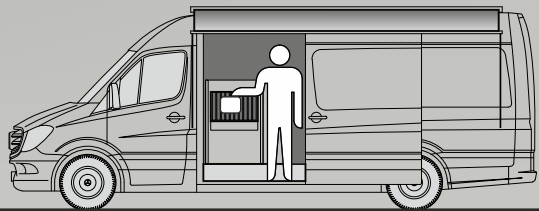



ARIDA Mobile family consists of various models. Full functionality may be limited to specific customer requirements. Mobile devices can be single view and multi view. The appliances constituting a single X-ray scanner, but also integrated solutions, such as Mobile Control Point (MPKB). On board you will find MPKB scanner dual view, gateway detection for humans and other additional systems. All scanners from mobile family are heavy duty, accurate and convenient to use. Reach wherever it is difficult to set a stationary scanner. Mobile is ideal for securing public events, borders, facilities, ports, and to protect every action that takes place at the open terrain.

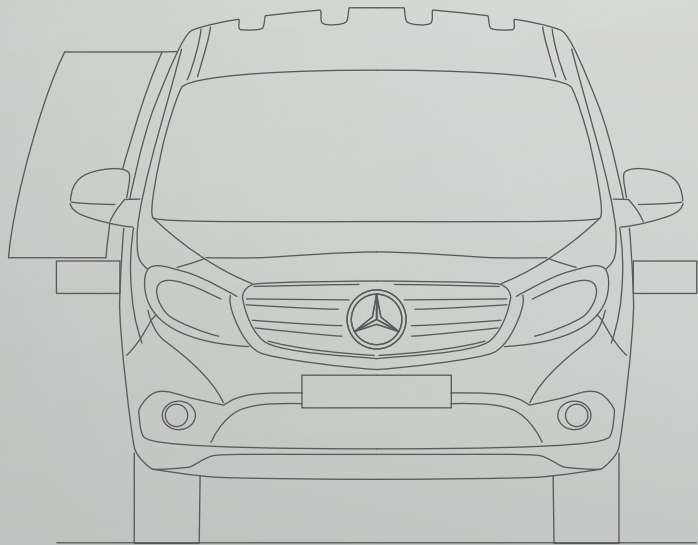

 ARDA CITAN MOBILE SCANNER



An absolute novelty from 2016

The unique light passenger vehicle with built-in X-ray. Based on the body of the Mercedes CITAN car. This is ideal for field work, to mass events protection and scanning packages. Parked all over the place. A fully functional system can detect any threats. Ask the dealer for details.

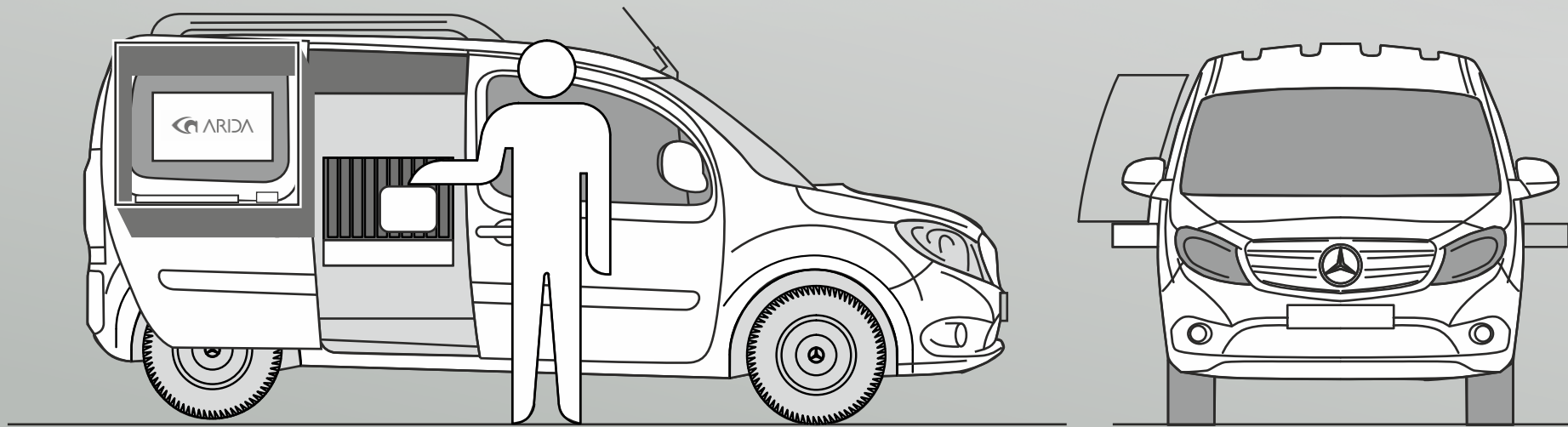



ARIDA GATE SCANNER

